

# Fencing & Balustrades



**WE WILL  
DELIVER**



**SPECIAL  
ORDERS**



**Protector<sup>AI</sup>**  
More than just fencing.

Available at  
**BUNNINGS**  
warehouse

**Take This Brochure** to the Special Orders Desk or order online at [bunnings.com.au](https://www.bunnings.com.au)

# Protector<sup>AI</sup>

More than just fencing.

Enhance the beauty, safety, and privacy of your pool, garden, and outdoor areas with fencing and balustrade options you can trust.

Some areas have product specifications that must be adhered to. Use our icons to know where our products can safely be used.

## Product icon key:

 **Ranged colours available in selected stores\***

\*Check with your local store to confirm range.

 **Order from Special Orders Desk<sup>†</sup>**

†Not available in-store.

## Product suitable for:

 Pool Fencing

 Garden Fencing

 Balustrade

## CONTENTS

4 Aluminium Pool Fencing

10 Glass Pool Fencing

14 Aluminium Balustrade

18 Glass Balustrade

22 Aluminium Garden Fencing

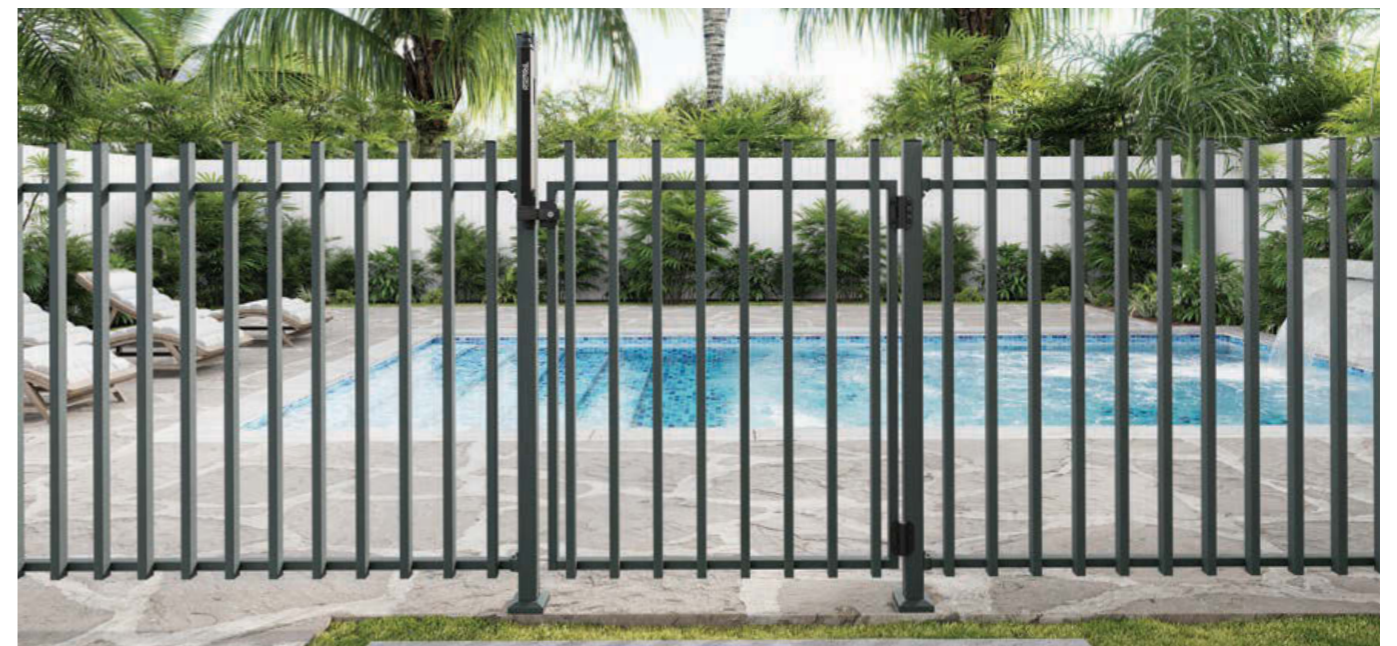

**Aluminium**

**Pool Fencing System**

**Our DIY Aluminium Pool Fencing System** has something for everyone, with a wide range of colours and styles. This complete off-the-shelf DIY system includes posts, panels, gates, gate hardware, and post lights.

Custom sizes, colours, raked and sloped panels are also available.

Meets AU Standard AS1926.1 and NZ Standard NZS 8500:2006 when installed correctly.

Pool fence panels and gates are backed by a 20-year warranty.

**20 YEAR WARRANTY**

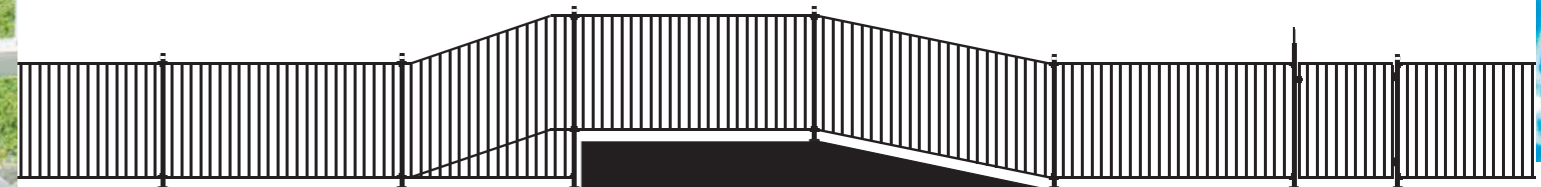

# Build Your Aluminium Pool Fencing

## Step 1. Select your fence style, size & colour



### Flat Top Round Picket Panel

Height: 1200mm, 1500mm & 1800mm

Width: 350mm up to 2400mm

Colour:

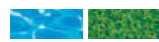

### Flat Top Square Picket Panel

Height: 1200mm, 1500mm & 1800mm

Width: 350mm up to 2400mm

Colour:



### Double Top Rail Panel

Height: 1200mm, 1500mm & 1800mm

Width: 350mm up to 2400mm

Colour:

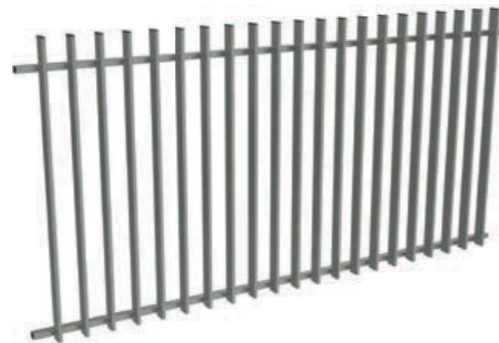
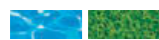

### Radiator Panel

Height: 1200mm, 1500mm & 1800mm

Width: 350mm up to 2400mm

Colour:



### Batten Panel

Height: 1200mm, 1500mm & 1800mm

Width: 350mm up to 2400mm

Colour:



### Picket Top Panel

Height: 1200mm, 1500mm & 1800mm

Width: 350mm up to 2400mm

Colour:



### Loop Top Panel

Height: 1200mm, 1500mm & 1800mm

Width: 350mm up to 2400mm

Colour:



### Spear Top Panel

Height: 1200mm, 1500mm & 1800mm

Width: 350mm up to 2400mm

Colour:



### Loop & Spear Top Panel

Height: 1200mm, 1500mm & 1800mm

Width: 350mm up to 2400mm

Colour:

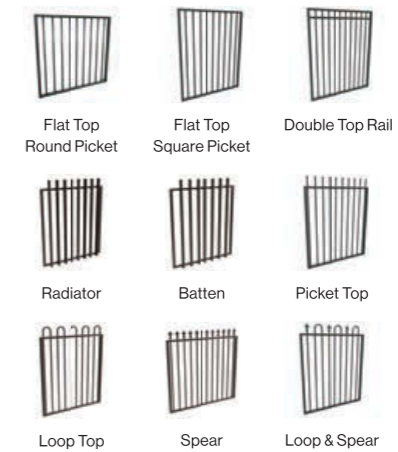

### Gates - Available in all styles

Height: 1200mm, 1500mm & 1800mm

Width: 800mm up to 1200mm

Colour:

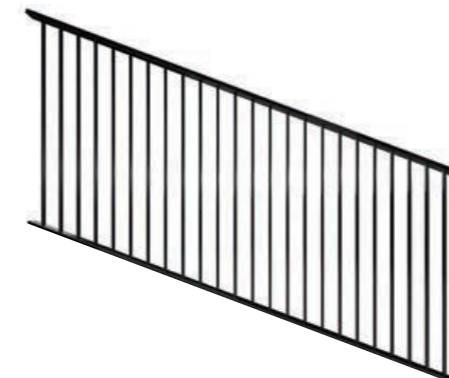

### Sloping Ground Panels - available in all fence styles & colours

Custom Raked or Sloped panels available for sloping ground to follow the fall of the land, rather than stepping "square" panels down. Maximum 30° slope. Visit [ProtectorAL.com.au](http://ProtectorAL.com.au) or your local Bunnings Special Orders Desk to find out more.



## Colour Options

Powder coat colours available for most aluminium components. Colours are indicative only.

Ranged colours available in selected stores

Order from Special Orders Desk

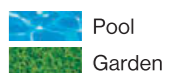
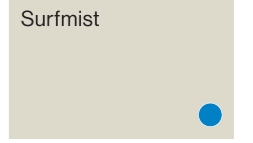
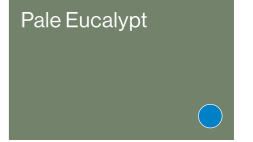
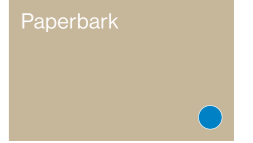
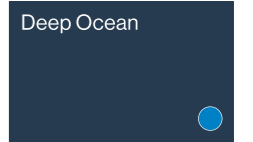
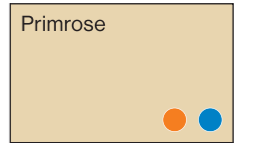
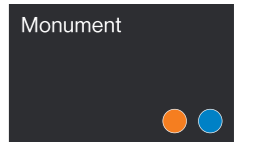
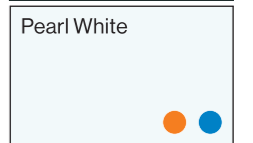

## Step 2. Select your post type, height & colour

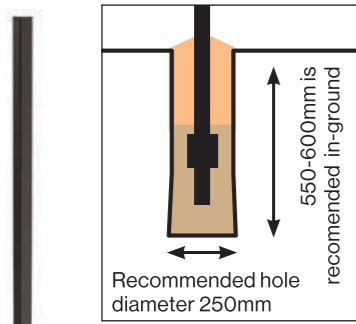

### In-ground Post

Height: 1800mm, 2100mm, 2400mm

Width: 50x50mm

Colour: ● ●

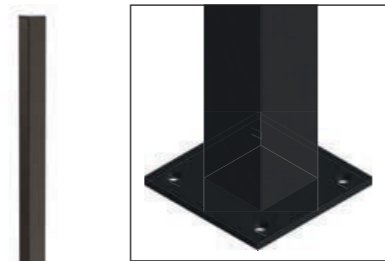

### Flanged Post

Height: 1300mm, 1600mm, 1900mm, 2400mm

Width: 50x50mm

Colour: ● ●



## Step 3. Select your hardware & colour

All ProtectorAI G8Safe latches and hinges are simple to fit and adjust making them ideal for the home handyman as well as for tradesmen who expect the best quality.

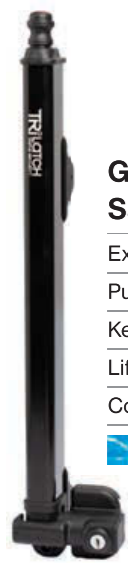

### G8Safe Trilatch Triple Safe Gate Latch

Extra Safe Gate Latch

Push Button & Pull Up Safety Action

Key Lockable

Lifetime Warranty

Colour: ●



### G8Safe Top Pull Gate Latch

Gate Latch Lockable

Key Lockable

Lifetime Warranty

Colour: ● ○

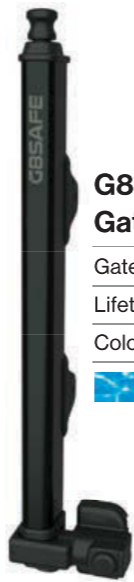

### G8Safe Top Pull Gate Latch

Gate Latch Keyless

Lifetime Warranty

Colour: ●



### G8Safe Gate Hinge Adjustable Self Closing

Colour: ● ○

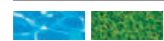

### G8Safe Gate Hinge Self Closing Fixed Tension

Colour: ●



Select your hardware & colour (continued).



### Panel Bracket

Connect panels to post/wall

3 Year Warranty

Colour: ● ●



### Raked Panel Bracket

For raked panels - maximum 15°

3 Year Warranty

Colour: ● ●



### Angle Bracket

For raked panels & corners - maximum 90°

3 Year Warranty

Colour: ● Plastic bracket



## Step 4. Select your accessories & colour



### Post Domical Cover

Cover bolt heads

3 Year Warranty

Colour: ● ○ ●

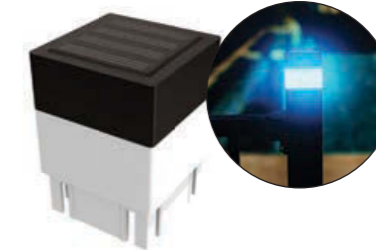

### Solar Post Light

White or Coloured light (Cycles colours)

Fits to ProtectorAI Aluminium Posts

3 Year Warranty



### Fence Post Cap

Ideal for In-ground and Flanged Posts

3 Year Warranty

Colour: ● Plastic cap



### CPR Chart

Weather resistant



## Colour Options

Powder coat colours available for most aluminium components. Colours are indicative only.

● Ranged colours available in selected stores

● Order from Special Orders Desk

Satin Black



Pearl White



Monument



Primrose



Deep Ocean



Paperbark



Pale Eucalypt



Surfmist



Woodland Grey



Palladium Silver



● Pool

● Garden

● Balustrade



Spigot profiles available as per page 12.

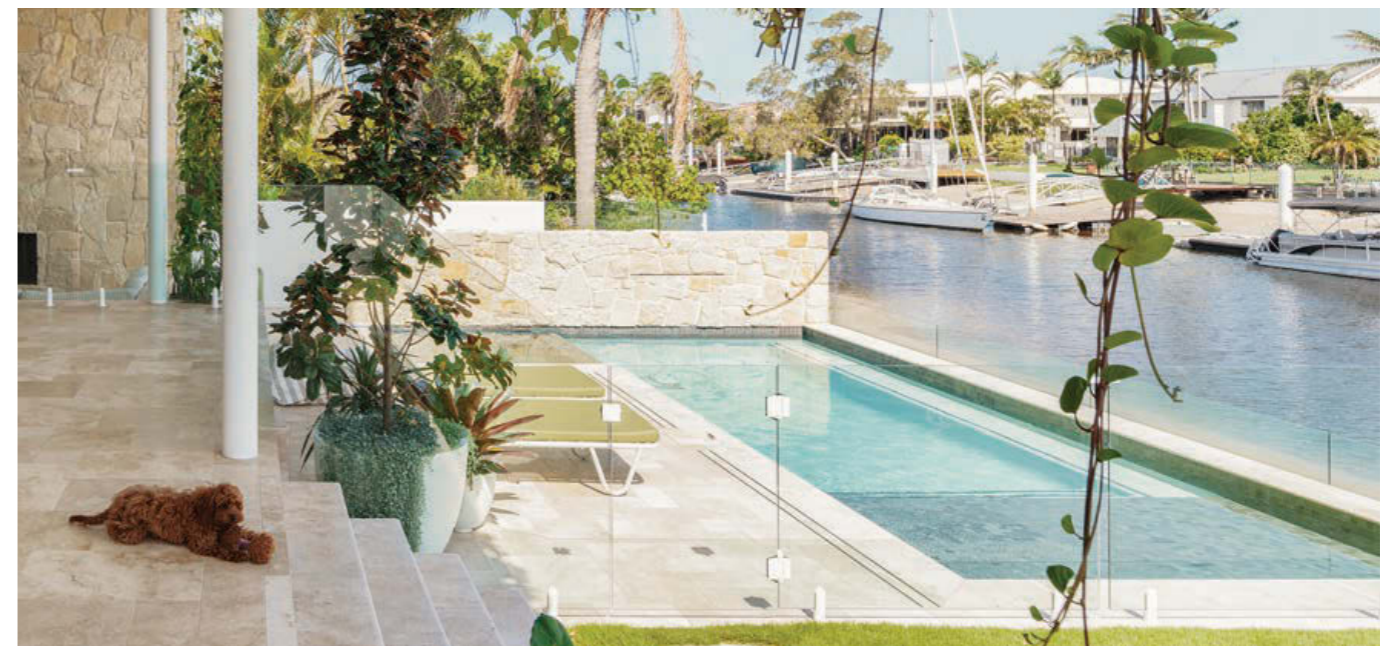

**Glass**

**Pool Fencing System**

Enjoy clean lines, clear views, and easy installation.

Our 12mm thick toughened glass Frameless Pool Fencing System is certified for use around a pool.

The system includes gate and hinge panels designed to fit our hinges and latches, to ensure alignment and fitting of a gate is quick and easy.

With a range of quality hardware fittings and finishes you can easily enhance the look of your pool area.

Meets AU Standard AS1926.1 + AS1288:2021 and NZ Standard AS/NZ 2208 when installed correctly.

**10 YEAR WARRANTY**

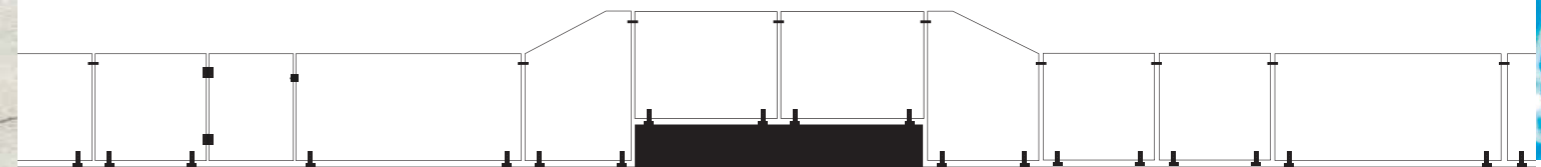

# Build Your Glass Pool Fencing

## Step 1. Select your panel and gate width



### Pool Panel

Height: 1200mm  
Width: 200mm up to 2000mm in 50mm increments



### Pool Hinge Panel

Height: 1200mm  
Width: 600mm, 800mm, 1000mm, 1100mm, 1200mm, 1300mm, 1400mm, 1500mm, 1600mm, 1700mm, 1800mm



### Pool Hinge Panel (Soft Close)

Height: 1200mm  
Width: 600mm, 800mm, 1000mm, 1100mm, 1200mm, 1300mm, 1400mm, 1500mm, 1600mm, 1700mm, 1800mm

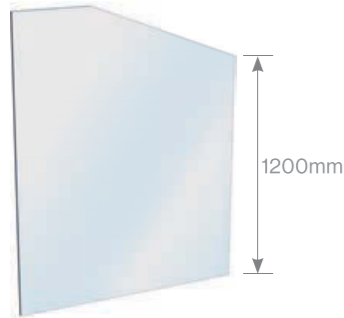

### Pool Retaining Wall Panel

For use next to retaining wall / climbing point  
Height: 1400mm, 1500mm, 1600mm, 1700mm, 1800mm

Width: 1200mm



### Pool Gate Panel

Height: 1200mm  
Width: 750mm, 834mm, 890mm & 1000mm



### Pool Gate Panel (Soft Close)

Height: 1200mm  
Width: 800mm, 900mm



## Step 2. Select your spigot type & colour



### Flanged Chisel Spigot

Colour: ▲▲



### Slimline Spigot

Colour: Mirror Polish only



### Core Drill Spigot

Colour: ▲



### Face Mount Spigot

Colour: ▲



### Colour Guide

- ▲ Ranged colours available in selected stores
- ▲ Order from Special Orders Desk

Satin Black	▲▲
Pearl White	▲▲
Mirror Polish	▲▲
Pool	▲
Balustrade	▲

## Step 3. Select your hardware & colour



### Gate Hinge Glass to Glass

Colour: ▲▲



### Gate Hinge Wall/Post to Glass

Colour: ▲▲



### Gate Soft Close Hinge Glass to Glass

Colour: ▲



### Soft Close Hinge Wall/Post to Glass

Colour: ▲



### Gate Latch Glass to Glass

Colour: ▲



### Gate Latch Wall/Post to Glass

Colour: ▲▲



## Step 4. Select your accessories & colour



### Friction Fit Clamp Glass to Glass

For extra stability in high wind areas

Colour: ▲



### Friction Fit Clamp Wall to Glass

For extra stability in high wind areas

Colour: ▲



### Friction Fit Clamp 90° Glass to Glass

For extra stability in high wind areas

Colour: ▲



### EnduroShield Glass Treatment

Glass treatment for all indoor and outdoor glass

Repels dirt, grime and hard water



### EnduroShield Glass Polish

Glass polish for restoring all indoor & outdoor glass

Use on stubborn stains and watermarks



### EnduroShield Professional Glass Maintenance Set

Glass Cleaning Kit for all indoor and outdoor glass

Includes glass washer and squeegee

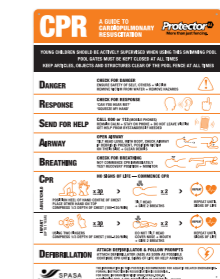

### CPR Chart

Weather resistant



**ProtectorAI**  
More than just fencing.

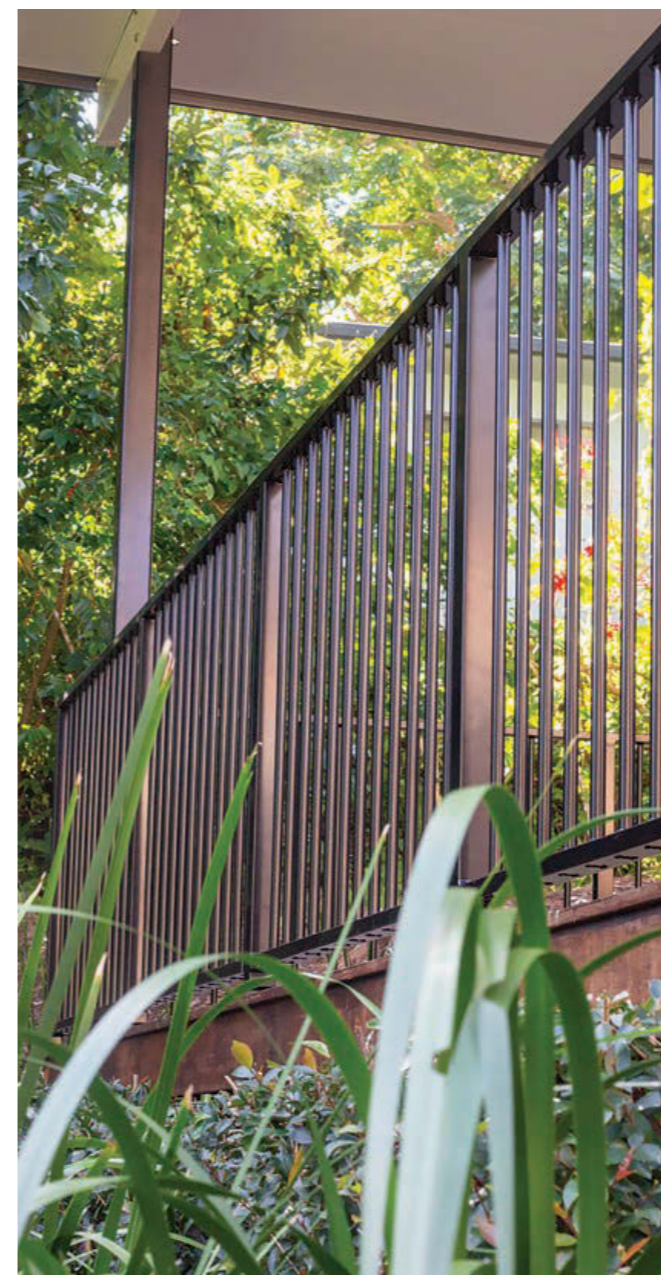

Aluminium

## Balustrade System

**The ProtectorAI Balustrade System is our easiest DIY system to date.**

Panels and posts sleeve together to make assembling your balustrade a breeze. Ideal for decks, balconies and indoor elevated spaces up to 4m from ground level.

Meets AU Standard NCC vol 1 DP3 + NCC Vol 1 Part 3.9.2 and NZ Standard NZBC B1/F4 when installed correctly.

Designed to last, our Balustrade System is backed by a 20 year warranty.

**20 YEAR WARRANTY**

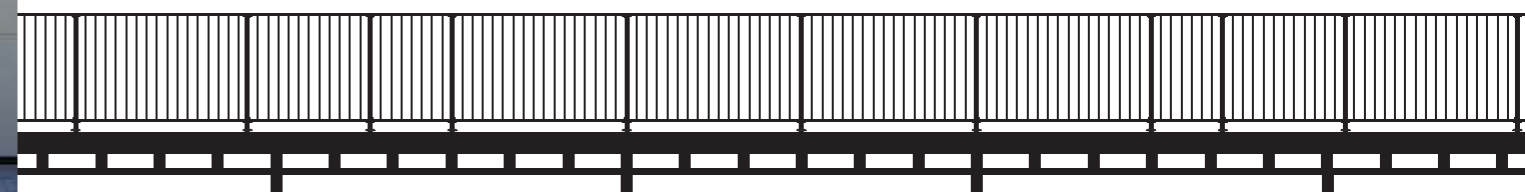

# Build Your Aluminium Balustrade

## Step 1. Select your balustrade style & colour



### Flat Top Round Picket Panel

Height: 950mm (Finished Height: 1010mm)

Width: 350mm up to 1800mm

Colour: ● ●

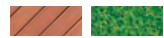

### Flat Top Square Picket Panel

Height: 950mm (Finished Height: 1010mm)

Width: 350mm up to 1800mm

Colour: ● ●



### Radiator Panel

Height: 1050mm (Finished Height: 1100mm)

Width: 350mm up to 1800mm

Colour: ●



### Batten Panel

Height: 1050mm (Finished Height: 1100mm)

Width: 350mm up to 1800mm

Colour: ● ●



**PLEASE NOTE: Balustrade Panels are not suitable for use as pool fencing.**

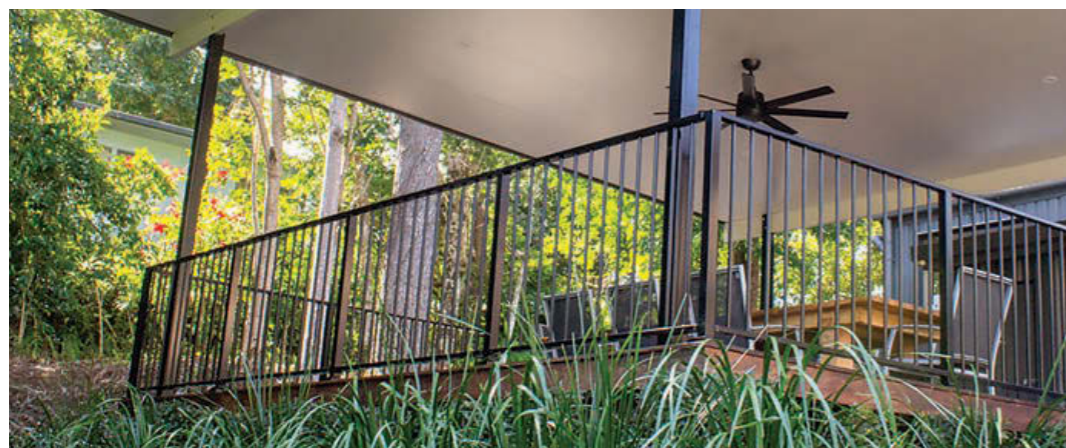

## Colour Options

Powder coat colours available for most aluminium components. Colours are indicative only.

● Ranged colours available in selected stores

● Order from Special Orders Desk

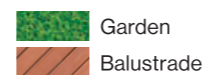
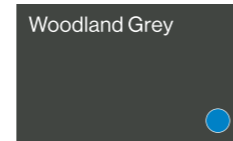
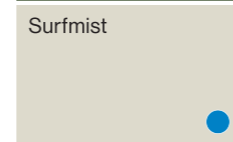
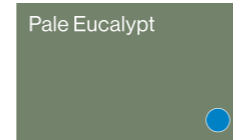
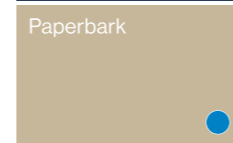
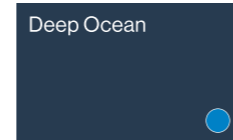
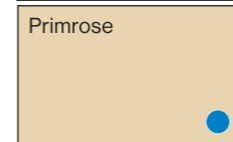
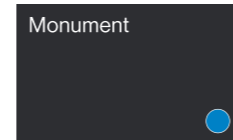
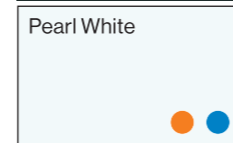
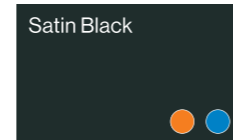

## Step 2. Select your post type & colour

Our ProtectorAI Aluminium Balustrade is our easiest DIY system to date, panels and posts simply sleeve together creating a seamless finish. Ideal for decks, balconies, and indoor elevated spaces.



### End Balustrade Post - Flanged

Height: 1010mm

Colour: ● ●

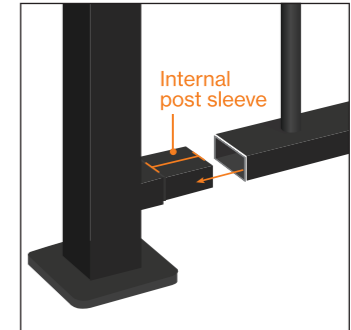

### 90° Balustrade Post - Flanged

Height: 1010mm

Colour: ● ●

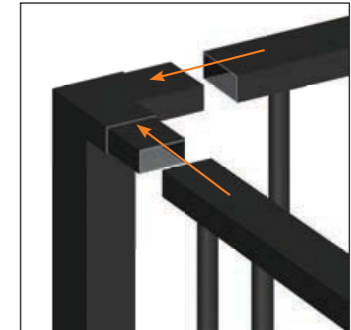

### Middle Balustrade Post - Flanged

Height: 1010mm

Colour: ● ●

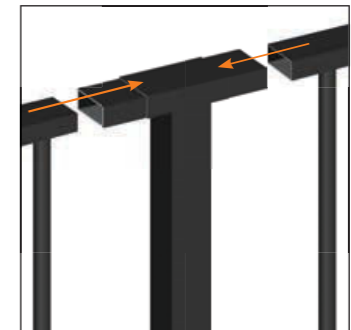

## Step 3. Select your hardware & colour



### Panel Bracket

Strong, Durable & Rust Resistant

3 Year Warranty

Colour: ● ●



## Step 4. Select your accessories & colour



### Post Domical Cover

Easy DIY

3 Year Warranty

Colour: ● ●



**Protector<sup>AI</sup>**  
More than just fencing.



Glass

## Balustrade System

Elegance taken to new heights. Clean lines, clear views and designed for DIY installation.

Our Frameless Balustrade Fencing System is a premium product certified for use up to 4 metres above ground level.

With a range of quality hardware fittings and finishes you can easily enhance the look of your outdoor area.

Meets AU Standard AS1288:2021 and NZ Standard NZS 8500:2006 when installed correctly.

**10 YEAR WARRANTY**

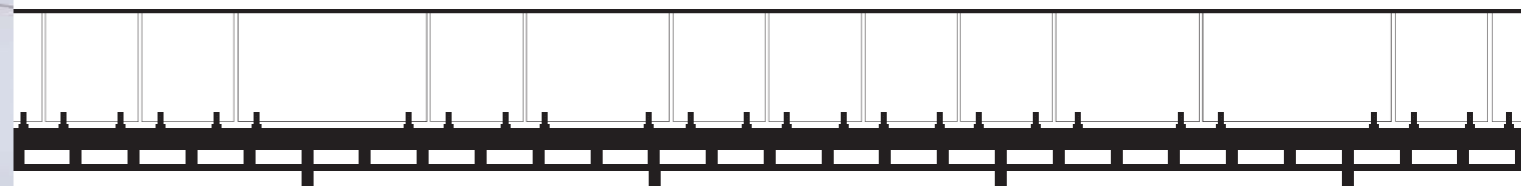

# Build Your Glass Balustrade

## Step 1. Select your panel width

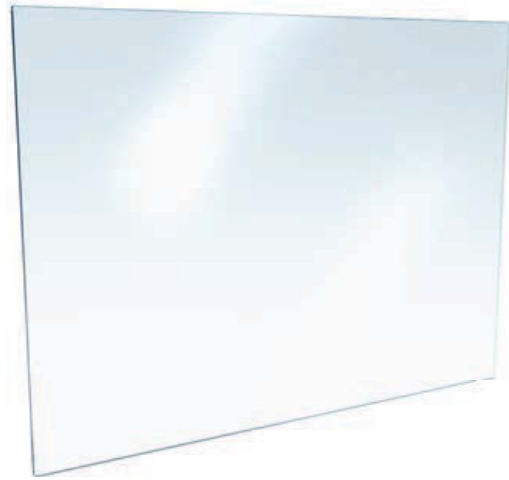

### Balustrade Panel

Height: 970mm, 1200mm

Width: 300mm up to 1800mm in 50mm increments

The overall finished height when used with ProtectorAI Handrail and Spigot is 1040mm.



### EnduroShield Treatment

EnduroShield is an invisible, non-stick coating product that reduces cleaning time by up to 90% by repelling water, scum and grime.



### EnduroShield Glass Polish

Glass polish for restoring all indoor & outdoor glass

Use on stubborn stains and watermarks



### EnduroShield Professional Glass Maintenance Set

Glass Cleaning Kit for all indoor and outdoor glass

Includes glass washer and squeegee



## Step 2. Select your spigot type & colour



### Chisel Spigot

Colour: ▲ ▲



### Slimline Spigot

Colour: Mirror Polish only



### Colour Guide

- ▲ Ranged colours available in selected stores
- ▲ Order from Special Orders Desk

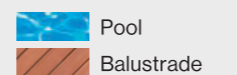
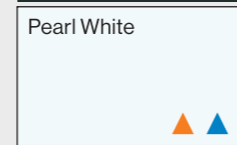
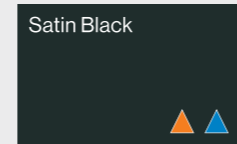

## Step 3. Select your handrail & colour



### Friction Fit Handrail

Handrail is required and must be fixed to the wall when fall is more than 1m.

Length: 2400mm

Colour: ▲



## Step 4. Select your accessories & colour



### Friction Fit Handrail Wall Bracket

Colour: ▲ ▲



### Friction Fit Handrail Corner Joiner

Join handrails at corners

Colour: ▲ ▲



### Friction Fit Straight Handrail Joiner

Join handrails for widths greater than 2400m

Colour: ▲ ▲



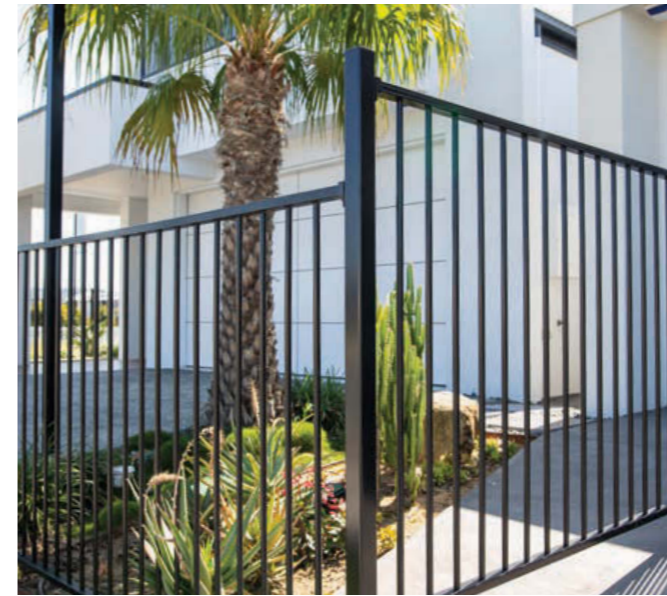

Aluminium

## Garden Fencing System

Define your space with quality aluminium garden fencing trusted to last.

Our garden fence styles can be used along with our pool fencing for any garden space around your home.

Our Garden Fencing System includes pedestrian and driveway gates, with hardware options to suit all applications.

Garden Fence Panels and Gates are backed by a 3 year warranty.

**3 YEAR WARRANTY**

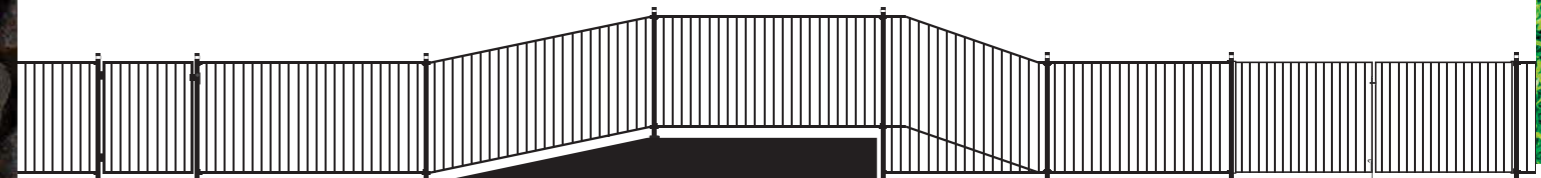

# Build Your Aluminium Garden Fencing

## Step 1. Select your fence style, size & colour



### Bishop Panel

Lightweight Fencing for Garden Use Only

Height: 1000mm

Width: 350mm up to 2000mm

Colour: ●



### Flat Top Round Picket Panel

Lightweight Fencing for Garden Use Only

Height: 900mm, 1200mm

Width: 2400mm

Colour: ●



### Flat Top Round or Square Picket Panel

Height: 1200mm, 1500mm & 1800mm

Width: 350mm up to 2400mm

Colour: ● ●



### Loop & Spear Top Panel

Height: 1200mm, 1500mm & 1800mm

Width: 350mm up to 2400mm

Colour: ●

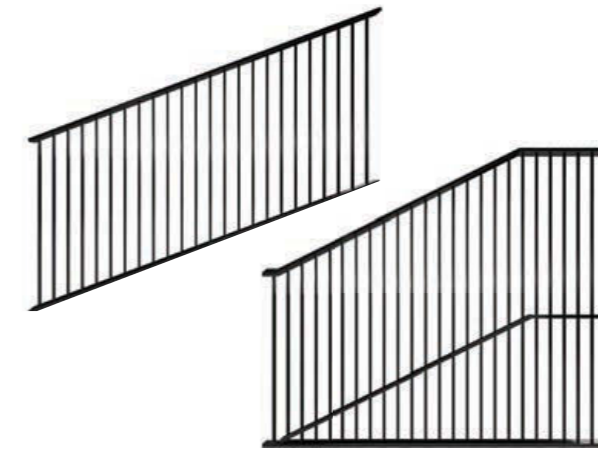

### Sloping Ground

Panels available in all fence styles

Custom Raked or Sloped panels available for sloping ground to follow the fall of the land, rather than stepping "square" panels down. Maximum 30° slope. Visit ProtectorAL.com.au or your local Bunnings Special Orders Desk to find out more.



### Double Top Rail Panel

Height: 1200mm

Width: 350mm up to 2400mm

Colour: ●



### Radiator Panel

Height: 1200mm, 1500mm & 1800mm

Width: 350mm up to 2400mm

Colour: ● ●



### Batten Panel

Height: 1200mm, 1500mm & 1800mm

Width: 350mm up to 2400mm

Colour: ● ●



### Pedestrian Gate

Height: 1500mm, 1800mm

Width: 800mm - 1200mm

Colour: ●



### Garden Gate

Height: 900mm

Width: 800mm - 1200mm, (975mm available in selected stores in Satin Black)

Colour: ●

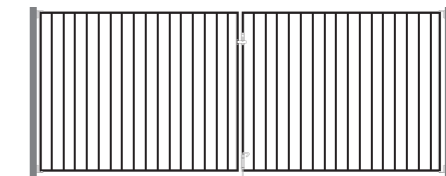

### Double Driveway Gate

Height: 900mm, 1200mm, 1500mm, 1800mm

Width: 1201mm - 1500mm

Colour: ●



### Picket Top Panel

Height: 1200mm, 1500mm & 1800mm

Width: 350mm up to 2400mm

Colour: ●



### Loop Top Panel

Height: 1200mm, 1500mm & 1800mm

Width: 350mm up to 2400mm

Colour: ● ●



### Spear Top Panel

Height: 1200mm, 1500mm & 1800mm

Width: 350mm up to 2400mm

Colour: ●



### Steel Adjustable Gate Frame Kit

Height: up to 1200mm

Width: up to 1100mm

Colour: ●

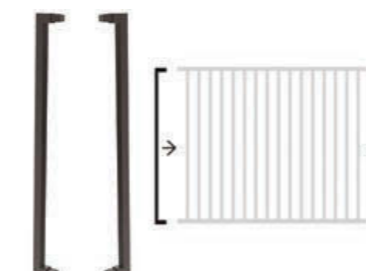

### Aluminium Gate Converter - 2 Pack

Height: 900mm, 1200mm

Colour: ●



### Aluminium Gate Frame Kit - for Steel Sheet Infill

Height: 1800mm finished height

Colour: ● ●



## Colour Options

Powder coat colours available for most aluminium components. Colours are indicative only.

● Ranged colours available in selected stores

● Order from Special Orders Desk

Satin Black



Pearl White



Monument



Primrose



Deep Ocean



Paperbark



Pale Eucalypt



Surfmist



Woodland Grey



Palladium Silver



● Garden  
● Balustrade

## Step 2. Select your post type, height & colour

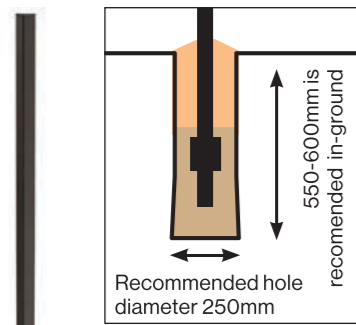

### In-ground Post

Height: 1400mm, 1800mm, 2100mm, 2400mm

Width: 50x50mm

Colour: ● ●

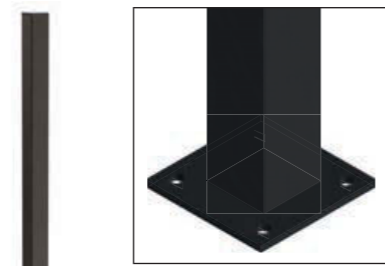

### Flanged Post

Height: 1000mm, 1300mm, 1600mm, 1900mm, 2400mm

Width: 50x50mm

Colour: ● ●



## Step 3. Select your hardware & colour

All ProtectorAI G8Safe latches and hinges are simple to fit and adjust making them ideal for the home handyman as well as for tradesmen who expect the best quality.

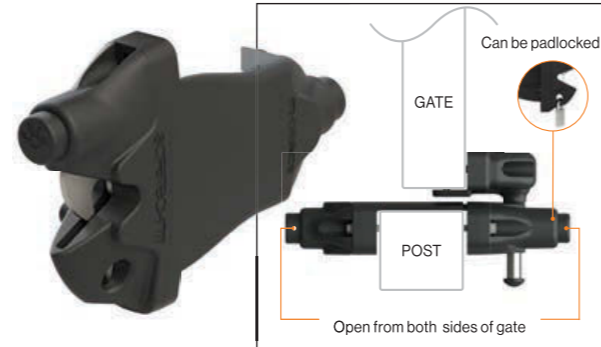

### G8Safe Double Sided Gravity-X Gate Latch

Can also be used for a single sided front access by only installing the front section of the gate latch.

Colour: ● ○



### G8Safe Trilatch Triple Safe Gate Latch

Extra Safe Gate Latch

Push Button & Pull Up Safety Action

Key Lockable

Lifetime Warranty

Colour: ●



### G8Safe Top Pull

Gate Latch

Lifetime Warranty

A Lockable Colour: ●

B Keyless Colour: ●



### G8Safe Compact Top Pull Gate Latch Lockable

Colour: ●



## Select your hardware & colour (continued).



### D-Latch & Striker

Colour: ● ●



### G8Safe Gate Hinge Adjustable Self Closing

Colour: ● ○



### G8Safe Gate Hinge Self Closing Fixed Tension

Colour: ●



### G8Safe Heavy Duty Gate Hinge Adjustable Self Closing

Colour: ●



### G8Safe Gate Hinge Non Self Closing

Colour: ●



### Gate Stop

Colour: ●



### Panel Bracket

Connect panels to post/wall

3 Year Warranty

Colour: ● ●



### Raked Panel Bracket

For raked panels - maximum 15°

3 Year Warranty

Colour: ● ●



### Angle Bracket

For raked panels & corners - maximum 90°

3 Year Warranty

Colour: ● Plastic bracket



### Gudgeon Hinges

Only suitable for 1800mm height gates up to 1500mm width

Colour: ● ●



### Drop Bolt

Colour: ● ●



## Step 4. Select your accessories & colour



### Post Domical Cover

Cover bolt heads

3 Year Warranty

Colour: ● ○ ●

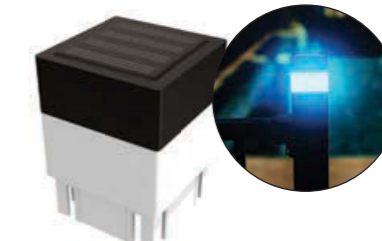

### Solar Post Light

White or Coloured light (Cycles colours)

Fits to ProtectorAI Aluminium Posts

3 Year Warranty



## Colour Options

Powder coat colours available for most aluminium components. Colours are indicative only.

● Ranged colours available in selected stores

● Order from Special Orders Desk

Satin Black



Pearl White



Monument



Primrose



Deep Ocean



Paperbark



Pale Eucalypt



Surfmist



Woodland Grey



Palladium Silver



Pool

Garden

Balustrade

# How It Works

---

It's as simple as 1,2,3! Follow the steps shown to purchase or order your product. If you need further advice, speak to a team member at the Special Orders Desk in-store.

---

## 1. Select The Product You Want

View the extensive range available in this brochure or online to select the item that best suits your needs.

---

## 2. Order at the Special Orders Desk

After you have selected the product you want, take this brochure to the Special Orders Desk or order online at [bunnings.com.au](http://bunnings.com.au)

---

## 3. Get It Home

### We Will Deliver\*

Delivery to your home or site can be arranged online or in-store when purchasing your products.

### Pick-Up In-Store

If you decide to pick-up in-store and need help to get it home, you can:

- borrow a courtesy trailer
- hire a vehicle

Check with your local Bunnings store for availability.

---